



30 AMP Solar Charge Controller User Manual



⚠ WARNING: Read and understand all instructions, warnings, and cautions before using this product. Failure to follow the instructions, warnings, and cautions may result in serious personal injury and/or property damage.

Item # 60032

SAVE THESE INSTRUCTIONS

1. Important Safety Instructions

This section contains important safety information. Before installing or using the unit, READ ALL instructions, and the provided cautionary markings. The unit contains no user-serviceable parts. See Warranty section for how to handle product issues.

Warning: Fire and/or Chemical Burn Hazard

- Do not cover or obstruct any air vent openings and/or install in a zero-clearance compartment.

Warning: Failure to follow these instructions can result in death or serious injury

- When working with electrical equipment or lead acid batteries, have someone nearby in case of an emergency.
- Wear eye protection and gloves.
- Avoid touching your eyes while using this unit.
- Keep fresh water and soap on hand in the event the battery acid comes in contact with eyes.

If this occurs, cleanse right away with soap and water for a minimum of 15 minutes and seek medical attention.

- Batteries produce explosive gasses. **DO NOT** smoke or have an open spark or fire near the system.
- Keep the unit away from moist or damp areas.
- Avoid dropping any metal tool or object on the battery. Doing so could create a spark or short circuit that goes through the battery or another electrical tool and may create an explosion.

Warning: Explosion hazard!

- DO NOT use the unit in the vicinity of flammable fumes or gasses (such as propane tanks or large engines).
- Prolonged exposure to high heat or freezing temperatures will decrease the working life of the unit.
- Use only 12V or 24V battery systems (the voltage is auto-sensed by the unit).
- Do not exceed the voltage and current ratings of the unit.
- Use only solar arrays with 25/ 50Voc max for 12/ 24V nominal battery systems respectively.
- Do not short circuit the solar array and/or the DC-Load port while connected to the unit.

This may permanently damage the unit.

- Protect the unit from direct sunlight.
- The unit is for **INDOORS** installation only.
- Try to install the unit as close to the battery bank as possible. The battery acts as a low pass filter reducing the chance for electrical noise, ripple, and interferences that may get into the unit. We suggest battery wires no longer than 6 feet each one (+ and -) when possible.

 **WARNING**

This product can expose you to chemicals, including Di (2-ethylhexyl) phthalate (DEHP) which is known to the State of California to cause cancer, birth defects or other reproductive harm. For more information, go to www.p65warnings.ca.gov

 **ADVERTENCIA**

Este producto puede exponerlo a productos químicos, incluidos Di (2-etilhexil) ftalato (DEHP) que el estado de California sabe que causa cáncer, defectos de nacimiento u otros daños reproductivos. Para obtener más información, vaya a www.p65warnings.ca.gov

2. Introduction

Noted: The charge controller always need to connected to a battery to test and function properly.

Thank you for purchasing the Nature Power 30A Digital Solar Charge Controller. With our state of the art, easy to use design, this product will offer you a reliable service to convert your solar energy to charge your low voltage battery system in an effective and efficient way. It also protects your battery from being overcharged by the solar panel, or over-discharged through the DC loads connected to terminals 5-6 (if any). The unit uses PWM (Pulse Width Modulation) current control techniques to regulate the charging current (and so the voltage) being supplied to the battery by the solar panel (or panels).

The display is a comprehensive one, with 3-1/2 digits and symbols, allowing you to check visually the operating status of the unit. It can show the digits and the corresponding symbols on the display, such as arrows, battery, light bulb, and sun.

The current in Amps represents the net one flowing to and from the battery.

Additionally, the unit allows you the setting of different battery type-dependent parameters, such as:

- Automatic Low Voltage Disconnect and Reconnect at the DC-Load port (on terminals 5-6).
- Maximum regulated voltage on the Bulk stage (for Lithium and Program only).
- The timers (up to three) for turning the DC-Load port on and off automatically according to the time of the day. This can be done manually as well by using the “Enter” button in Normal Operating mode.

The unit protects itself and provides the corresponding error alarms against the following conditions:

- Reversed polarity on either the battery and/or the solar panel ports.
- Current overload condition on either the DC-Load and/or the solar panel ports.
- Internal over temperature.

3. Understanding the unit

Caution: This unit is designed for use with 12V or 24V nominal Battery Systems only

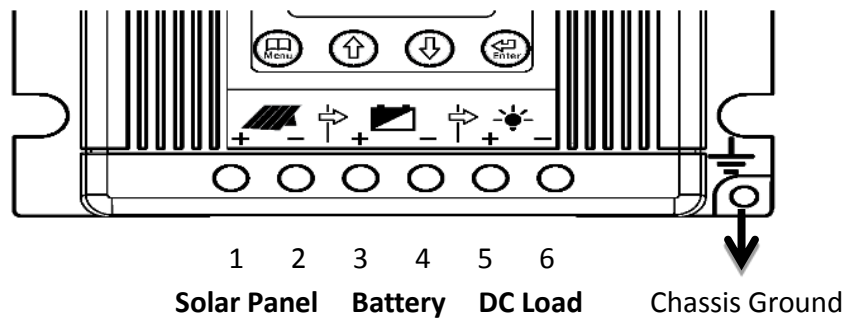

- Terminals 1 and 2 are the input port for the solar panel connection.
- Terminals 3 and 4 are used for the battery connection. They act as both an output port, for charging the battery from the solar panel, and an input port for discharging the battery to the DC loads (if any) through the controller (on terminals 5 and 6).
- Terminals 5 and 6 are the output port for the DC loads with a total current draw equal or less than 30A, such as DC light bulbs and small to medium power DC appliances.

Notes ①:

- The use of the DC-Load port on terminals 5 and 6, is optional (you can keep them disconnected). It is useful to provide an automatic Battery Under Voltage Load Disconnect feature to the DC loads connected there, in an effort to avoid over-discharging the battery when its state of charge (SoC) condition is getting low.
- No external jumpers between each negative terminal are required.

Caution: Connecting DC loads on the terminals 5-6 that can draw either peak or continuous currents that exceed the maximum rating of 30A, could damage the unit permanently, and that would not be covered by the warranty. Heavy-duty DC loads, (such as inverters), have to be connected **directly** to the battery terminals.

Operating Modes: The unit has the following three operating modes:

- **Normal Operating Mode:** This is the default mode where the unit automatically starts and eventually returns from other operating modes if no action is performed within 10 sec. It shows the battery voltage (default) or the current (after pushing whatever arrow button), together with all the symbols except the ones related to the timers and real time clock (☀, ☀ OFF, and PM)
- **Unit Setting Mode:** This is the mode for setting and editing all the programmable parameters of the unit. In this mode, only the symbols related with the specific parameter being shown are displayed, except the battery symbol, which should remain flashing in all the operating modes. The only way for getting out of this mode and returning to the Normal Operating Mode is waiting 10 sec without touching any push button.
- **Setting Display Mode:** This is the mode for reading the settings without the risk of changing them accidentally. It is very similar to the Unit Setting Mode (e.g. in regards to the symbols and the sequence of the parameters) except that the arrows push buttons are used for scrolling up or down circularly through the settings other than for increasing or decreasing their values.

Push Buttons Functions: ('Menu', 'Enter', Up '↑', and Down '↓').



In Normal Operating Mode:

Press once to enter the **Setting Display Mode** to read the unit settings without the risk to change them accidentally. Once in the Setting Display mode, press the **Up/Down** buttons to scroll circularly through the parameters settings (Real Time Clock, Battery Type, Lithium/Program Bulk Voltage, DC-Load Voltage Disconnect and Reconnect on terminals 5-6, and the start and duration of the timers).

In Setting Display Mode:

Press once to exit the Setting Display Mode and return to Normal Operating Mode; (the same occurs automatically without pressing any push button for 10 sec.)

In either Normal Operating Mode or Setting Display Mode:

Press and hold for more than 3 seconds to enter the Unit Setting Mode. Once in the Unit Setting Mode, you need to wait 10 sec without pressing any push button to return to Normal Operating Mode.

In Unit Setting Mode:

Press once to skip to the next parameter setting if no change is required in the one being displayed.



In Normal Operating Mode:

Press and hold for more than 3 sec to turn manually the DC-Load port ON or OFF

In Unit Setting Mode:

Press once to confirm or save the setting and proceed to the next parameter setting (see more details in section 9 'Understanding the Unit Setting Mode').

In Setting Display Mode:

Nothing happens. It does not have any effect.



In Normal Operating Mode:

- Press either the **Up** or **Down** button to change the display in between battery voltage and charging current measurements.

- Press and hold both buttons for 3 seconds to read the software revision number (e.g. "r1.7").



In Unit Setting Mode:

Press the **Up** or **Down** button to edit the parameters settings.

In Setting Display Mode:

Press the **Up** or **Down** button to scroll up or down through the settings reading.

4. Three-stage charging algorithm:

The unit provides a 3-stage charging algorithm having a Bulk, then Absorption and then Float stage sequence. During the Bulk stage, the battery accepts all the possible current from the solar panel (if available) in an effort to charge the battery and so raising its voltage. Once the battery voltage reaches the maximum one^② (depending on the setting), the unit passes from Bulk to Absorption stage, keeping that maximum voltage by reducing the charging current if necessary under a PWM regulation approach. When entering the Absorption stage, a two-hour timer starts running. During that period, if the battery voltage drops 0.3V below the Absorption voltage^②, the timer will restart. When the Absorption timeout occurs, the unit pass to the Float stage supplying a lower voltage to maintain the battery in a fully charged state. The controller will automatically restart the full charging cycle if it senses the battery bank is discharged to less than 12.5V/25V in 12V/24V battery systems respectively.

Note ^②: The maximum voltage in Bulk stage corresponds to the Absorption one, being the threshold to pass from Bulk to Absorption stage. Wherever its setting is allowable to the user, the display will show the “Bulk” symbol other than the “ABS” one (see the section 9 for more details).

5. Installation Instructions:

Caution: Before installing the unit, please verify the rating of the solar panel, the battery type and its nominal voltage, and the total power consumption of the DC loads.

Max. Current	Battery Voltage	Battery Type	Maximum Solar Panel Rating	Allowable Direct ^③ /Min. wire Gauge respectively
30A	12V or 24V (Self detection)	Gel, AGM, Flooded, Lithium Programmable	480W-12V (12V system) 960W-24V (24V system)	#6 / #10 AWG

Note ^③: As per the physical connector of the unit, and/or the crimping terminals being used. However, thicker wires can be used for the solar panel array to compensate excessive power losses (resistance) on long runs, by reducing their thickness on the last edge inches (e.g. by splicing two 4” long thinner wires). That bottleneck would not affect the power losses, being insignificant in 4” long thinner wires and always thick enough for the unit maximum current rating.

Step 1: Select the Battery type. Refer to the next section (“Understanding the Unit Setting”).

Step 2: Connect the positive and negative terminals of the PV, Battery and DC Loads accordingly. Check their polarity before connecting.

Unit Mounting: Select an appropriate mounting Indoor location not susceptible to extreme heat, humidity, and dirty conditions. The unit can be oriented in any direction. Allow free space around the unit for heat dissipation purposes. Install the controller as close as possible to the battery (the battery acts like a low pass filter, helping the reduction of electrical noises and interferences on the DC wiring). Hold the controller against the mounting surface and mark the positions of its mounting holes on its flanges. Then, make the pilot holes with a drill.

6. Display Functions and Symbols:

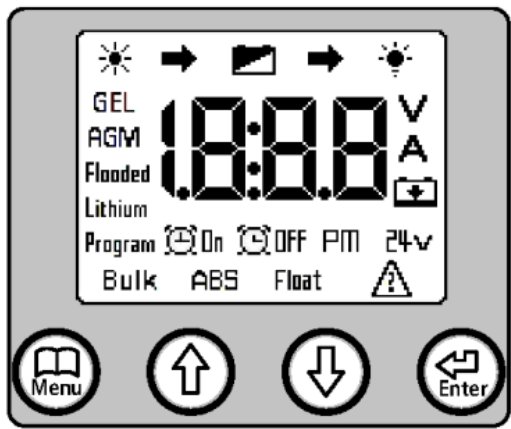

- } These Symbols show the charging and discharging status in the Normal Operating Mode only
- } Symbols shown in all the modes and according to the specific conditions at the moment
- } Push buttons with multiple functions, according to the specific operating mode at the moment

7. Understanding the Display Symbols:

Meanings of the basic display symbols:

- Solid:** The solar panel is detected (--> its voltage, on the terminals 1-2, is higher than $\approx 6.2V$ or $11.2V^*$). It could take up to 10 sec to be updated to a new Off condition (since the moment its voltage drops below $\approx 4.2V$ or $9V^*$ respectively). ***Note:** according to the version of the unit.
- Flashing:** The battery is detected. Its voltage has to be higher than about 6.2 – 6.4V for the controller to operate. It should be flashing permanently in all the operating modes. Otherwise, the controller must be reset as indicated in the troubleshooting table section 14 (point ⑥). **Purpose:** To indicate that the unit is alive and running OK.
- Solid:** The DC-Load port (on terminals 5-6) is ON.
- Flashing:** The DC-Load port should be ON but it is forced to be OFF due to one or more of the following alarm conditions: **a) E05:** DC-Load Under Voltage Shutdown; **b) E03:** DC-Load Overload; **c) E04:** Unit Over Temperature Shutdown. Otherwise, the DC-Load port would be already ON. Since the DC-Load port is disconnected, the corresponding flashing current flow arrow consequently goes off (if it was on). **PURPOSE:** This is to alert the user that the DC Loads (connected to terminals 5 and 6) could start running at any time, once those error conditions disappear.
- Flashing:** Flow of current in between the symbols above. It should remain flashing (not solid). It takes up to 10 /30 sec to be updated to a new flashing/off condition respectively.

Meanings of the basic display symbols combined:

Symbol	Description (with the battery/bulb symbols always flashing/solid respectively)
	Solar power is being supplied to the battery. The DC-Load port is ON and the load is drawing current from the battery.
	Solar power is being supplied to the battery. The DC-Load port is ON and there is no load, or it is very low to be detected .
	Solar power is being supplied to the battery. The DC-Load port is OFF.
	The solar panel is detected but does not have enough voltage to charge the battery. The DC-Load port is ON and the load is drawing current from the battery.

	The solar panel is detected but does not have enough voltage to charge the battery. The DC-Load is ON and there is no load, or it is very low to be detected.
	The solar panel is unavailable (e.g. at night or disconnected). The DC-Load port is ON and the load is drawing current from the battery.
	The solar panel is unavailable (e.g. at night or disconnected). The DC-Load is ON and there is no load, or it is very low to be detected.
	The solar panel is unavailable (e.g. at night or disconnected). The battery is connected. The DC-Load port is OFF.

Display Symbols during 'Setting Display', 'Unit Setting', or 'Normal Operating' modes	
GEL AGM Flooded Lithium Program	These symbols indicate the battery type. Note: Some units may have symbols showing 'Flo' / 'Li' / 'Pro' instead of 'Flooded' / 'Lithium' / 'Program' respectively.
Bulk ABS Float	The related symbol shows the charging stage at the moment (Bulk, Absorption, or Floating). They are mutually exclusive (only one at a time). They may take up to 10 sec to be updated to a new different stage. In both Unit Setting and Setting Display modes having either Lithium or Program selected, the "Bulk" symbol goes on to indicate the Absorption voltage setting (see note ②)

	In "Unit Setting" and "Setting Display" Modes with "C01" (timers enabled): The display is showing 1 of the 3 DC-Load ON or OFF timers values, as per the symbol being shown, which flashes periodically with 1, 2, or 3 pulses pattern to indicate that the value corresponds to the timer 1, 2, or 3 respectively. In "Unit Setting" and "Setting Display" Modes with "C00" (timers disabled): These alarm clock symbols are not showed when they are disabled. Note ④: these symbols never appear in Normal Operating Mode.
24V	In any condition, the '24V' symbol indicates that a 24V battery system has been detected and is in use. Otherwise, It remains OFF indicating a 12V battery system.
	In Normal Operating Mode: The display is showing the <u>net</u> battery <u>discharging</u> current in Amps. In other words, the charging current from the solar panel is less than the discharging current by the DC loads on terminals 5-6, so the battery is discharging supplying the difference of current and showing it on the display. In "Unit Setting" and "Setting Display" Modes: Solid/Flashing means that the display is showing the DC-Load port Disconnect /Reconnect Voltage respectively.
18:88	The display shows time/Net battery charging or discharging current/ Battery voltage/Timer setting/Error code, e.g. 12:04/21.2/12.3/C01 or C00/E02 respectively.
PM	This symbol indicates the afternoon time ('Post Meridieum').
A	The display is showing the <u>net</u> battery charging/discharging current in Amps.
V	The display is showing the battery voltage in Volts.
	Error is detected and the display is showing its code in the E01-E05 range.

8. About the net battery charging and discharging conditions shown on the display:

As already mentioned in the previous table, the current in Amps shown on the display is the net one, being the result of the one provided by the solar panel minus the one being drawn by the DC loads connected to the terminals 5-6 of the unit (if any).

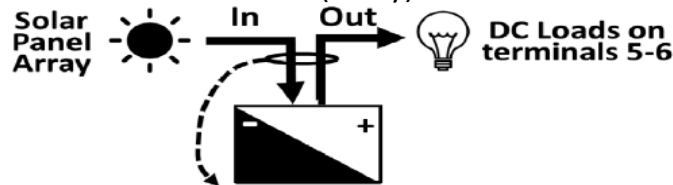

NET BATTERY CURRENT SHOWN ON THE DISPLAY

Note ⑤: The net current shown on the display (so the charging and discharging condition) relates to the solar panels and DC Loads (if any) connected to the corresponding ports on the controller. Whatever current being supplied/drawn to/from the battery by other external sources/loads respectively that are connected directly to the battery terminals, are out of the controller monitoring range. If that were the case, the displayed net current could be meaningless or incomplete.

Some examples in Normal Operating Mode:

The following table shows several conditions for illustration purposes. It is based on a 12V AGM type battery with a 5.7A DC load. All the possible combinations are not shown.

Display/Case #	Current flows	Description
Case #1: Display showing no solar panel power available and the DC-Load port is OFF		
	<p>Net current = 0A Neither charging nor discharging</p>	<ul style="list-style-type: none"> ☑ ->Flashing as should be always to indicate unit is running. ☀ ->Off, to indicate no current is flowing from the solar panel, at least not a perceptible one. It is either disconnected or at night condition, so its arrow is not shown. 💡 ->Off, to indicate DC-Load port is OFF, so no current from the battery to the DC-Load terminals -->No arrow is shown AGM -->Battery type setting is shown, being, in this case, AGM See the net current in Amps by pushing the ⬆ or ⬇ buttons Neither charging nor discharging.
Case #2-1: Display showing no solar panel power available and the DC-Load port is ON		
	<p>Net from Bat: -5.7A (discharging)</p>	<ul style="list-style-type: none"> ☑ ->Flashing as should be always to indicate unit running. ☀ ->Off to indicate that no current is flowing from the solar panel, at least not a perceptible one. It is either disconnected or at night condition, so its arrow is not shown. 💡 ->On, to indicate DC-Load port is ON, so there is a current from the battery to the DC-Load terminals -->arrow is flashing AGM -->Battery type setting is shown, being, in this case, AGM See the net current in Amps by pushing the ⬆ or ⬇ buttons Net battery current = -5.7A (discharging) ⬇ ->Solid ON, indicating discharging (negative) current

Case #2-2: Display showing solar panel power available and the DC-Load port is OFF

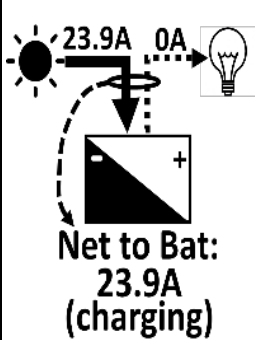
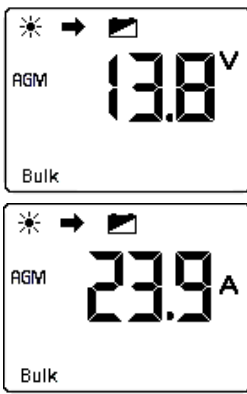

- [Battery icon] ->Flashing as should be always to indicate unit running.
- [Sun icon] -->On to indicate current is flowing from the solar panel to the battery, so the corresponding flow arrow is flashing
- [Light bulb icon] ->Off, to indicate DC-Load port is OFF, so no current from the battery to the DC-Load terminals -->No arrow is shown
- AGM -->Battery type setting is shown, being, in this case, AGM
- See the net current in Amps by pushing the \uparrow or \downarrow buttons
- Net battery current = 23.9A (charging)
- Bulk -->On, as the charging stage at the moment

Case #2-3: Display showing solar panel power available and the DC-Load port is ON

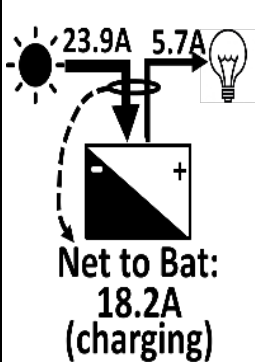
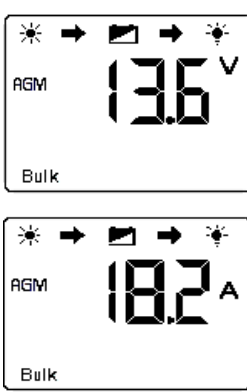

- [Battery icon] ->Flashing as should be always to indicate unit running.
- [Sun icon] -->On to indicate current is flowing from the solar panel to the battery, so the corresponding flow arrow is flashing
- [Light bulb icon] ->On, to indicate DC-Load port is ON, so there is a current from the battery to the DC-Load terminals -->arrow is flashing
- AGM -->Battery type setting is shown, being, in this case, AGM
- See the net current in Amps by pushing the \uparrow or \downarrow buttons
- Net battery current = 23.9A – 5.7A = 18.2A (charging)
- Bulk -->On, as the charging stage at the moment

Case #2-4: Display showing a lower solar panel power available and the DC-Load port is ON

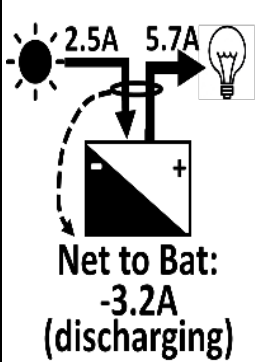
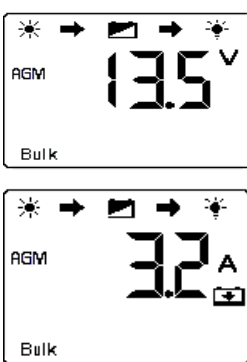

- [Battery icon] ->Flashing as should be always to indicate unit running.
- [Sun icon] -->On to indicate current is flowing from the solar panel to the battery, so the corresponding flow arrow is flashing
- [Light bulb icon] ->On, to indicate DC-Load port is ON, so there is a current from the battery to the DC-Load terminals -->arrow is flashing
- AGM -->Battery type setting is shown, being, in this case, AGM
- See the net current in Amps by pushing the \uparrow or \downarrow buttons
- Net battery current = 2.5A – 5.7A = -3.2A (discharging)
- [Battery icon with minus sign] -> Solid ON, indicating discharging (negative) current
- Bulk -->On, as the charging stage at the moment

Case #2-5: Display showing solar panel power available and almost equal to the DC-Load one

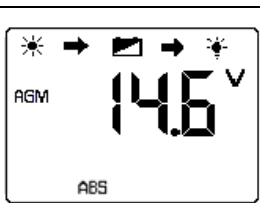
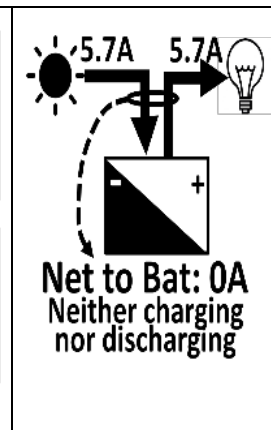
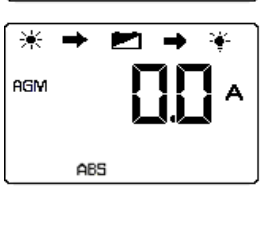
 <p>AGM 14.6 V ABS</p>	 <p>5.7A 5.7A Net to Bat: 0A Neither charging nor discharging</p>	<ul style="list-style-type: none"> ☑ ->Flashing as should be always to indicate unit running. ☀ -->On to indicate current is flowing from the solar panel to the battery, so the corresponding flow arrow is flashing 💡 ->On, to indicate DC-Load port is ON, so there is a current from the battery to the terminals -->arrow is flashing AGM -->Battery type setting is shown, being, in this case, AGM See the net current in Amps by pushing the ⬆ or ⬇ buttons Net battery current = 5.7A – 5.7A = .0A (neither charging nor discharging). ABS -->On, as the charging stage at the moment (after Bulk)
 <p>AGM 0.0 A ABS</p>		

Case #3: An 'Low Voltage Disconnect' occurred in the DC-Load port when it was on.

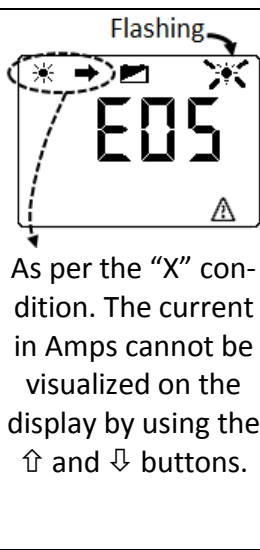
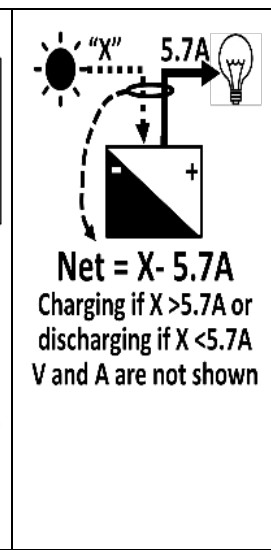
 <p>Flashing E05 ⚠</p> <p>As per the "X" condition. The current in Amps cannot be visualized on the display by using the ⬆ and ⬇ buttons.</p>	 <p>"X" 5.7A Net = X - 5.7A Charging if X > 5.7A or discharging if X < 5.7A V and A are not shown</p>	<ul style="list-style-type: none"> ☑ ->Flashing as should be always to indicate unit running. ☀ -->either On or Off according to the specific "X" condition. Same for its current flow arrow, but flashing instead of On. 💡 ->Flashing, to indicate that the DC-Load port (that was On and now is Off) should continue being ON if the DC-Load Disconnect "E05" would not have occurred No action occurs after pushing either the ⬆ or ⬇ buttons, the display remains the same, showing the "E05". ⚠ ->On to indicate that an "Exx" type alarm/error occurred Battery chemistry (AGM in these examples) is not shown. Once the battery voltage rises enough so the E05 error condition disappears, the DC-Load restarts again if it was not turned Off either manually or through the timers settings.
---	---	---



IMPORTANT: See note ⑤ for more details about the charging and discharging conditions.

9. Understanding the Unit Setting Mode:

Even though the unit comes already with factory default settings (see section 15 'Specifications'), some of them require being done by yourself. For example, since the DC-Load output port (terminals 5-6) could be turned ON and OFF automatically (in addition to manually), may require the setting of up to three different programmable timers. If so, the real-time clock (that runs even when there is not any power source present) would require being set as well to your local time. All the settings are saved in flash memory, so remaining at power off even if the unit is stored for a long period without use.

To enter the Unit Setting Mode, press and hold the 'Menu'  button for 3 seconds. Once within that mode, the unit automatically terminates it and returns to Normal Operating Mode after reaching a 10 seconds timeout with no buttons being pressed.

The sequence of the parameters in the Unit Setting Mode is as follow.







In the Setting Display Mode, the parameters are shown in the same order but having different functions for the Up and Down arrow   pushbuttons.

Step 1: Real Time Clock Setting



12:08
PM

The Real Time Clock is shown on the display, with the hour number e.g. '12' flashing to indicate that the hour setting is in place.





- Press the 'Menu'  pushbutton if an adjustment of the Real Time Clock is not required, so this menu will jump to Step 2.
- If an adjustment of the Real Time Clock is required, use the   pushbuttons to adjust the hour time.
- The 'PM' symbol indicates afternoon ("Post Meridiem") time.
- Press the 'Enter'  pushbutton once to set/save the hour time .
- Then, the minute number e.g. '08' flashes to indicate that its setting is in place.
- Use the   pushbuttons to adjust the minutes time.
- Press 'Enter'  pushbutton once to set/confirm the minute time.
- The Real Time Clock setting finished, so this menu will jump to Step 2.

Step 2: Battery Type Setting



GEL
AGM
Flooded
Lithium
Program

The battery type is displayed with the one of the present setting flashings.







- Press the 'Menu'  pushbutton if the battery type does not require any changes, so this menu will jump to Step 5.
- Use the   pushbuttons to change to different battery type.
- The selected battery type will be flashing.
- Press the 'Enter'  pushbutton once to set/confirm the new battery type.
- If the Lithium battery type is selected, this menu will jump to Step 3.
- If the Program battery type is selected, this menu will jump to Step 4.
- If another different battery type is selected, this menu will jump to Step 5*.

Step 3: Lithium Battery Voltage Setting (if Lithium battery is selected)



Lithium
Bulk
13.9^V

•The 'Lithium' and 'Bulk' symbol is flashing.

- Press the 'Menu'  pushbutton if the Lithium voltage settings do not require any changes, so this menu will jump to Step 5.
- Use the   pushbuttons to adjust the max. Bulk voltage² setting for the Lithium battery. Check the range for this value in the section 15 ('Specifications').
- Press the 'Enter'  pushbutton once to set/confirm the max. Bulk voltage²
- Use the   pushbuttons to adjust the Float voltage setting for the Lithium battery. Check the range for this value in the section 15 ('Specifications').
- Press the 'Enter'  pushbutton once to set/confirm the Float voltage setting, and this menu will jump to Step 5.

Note: The Float voltage has to be set to at least 0.2V below the Bulk Voltage setting. The unit blocks/changes invalid ones (see section 15 'Specifications').

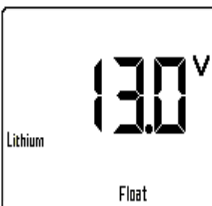





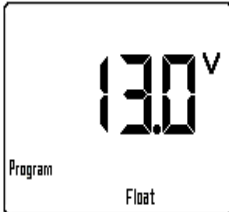

Lithium
Float
13.0^V

Step 4: 'Program' Battery Voltage Setting





The 'Program' symbol is flashing





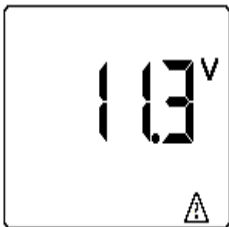
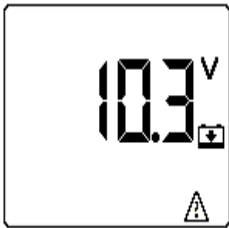



- Press the 'Menu'  pushbutton if the voltage setting on the 'Program' battery does not require any changes, so this menu will jump to Step 5.
- Use the   pushbuttons to adjust the Bulk voltage^② setting for the 'Program' battery. Check the range for this value in the section 15 ('Specifications').
- Press the 'Enter'  pushbutton once to set/confirm the max. Bulk voltage^②.
- Use the   pushbuttons to adjust the Float voltage setting for the 'Program' battery. Check the range for this value in the section 15 ('Specifications').
- Press the 'Enter'  pushbutton once to set/confirm the Float voltage setting, and this menu will jump to Step 5.

Note: The Float voltage has to be set to at least 0.2V below the Bulk Voltage setting. The unit blocks/changes invalid ones (see notes in section 15 'Specifications').

Step 5: DC-Load (terminals 5-6) Disconnect and Reconnect Voltage Settings



The Disconnect Voltage Setting and the symbol  are shown on the display

- Press the 'Menu'  pushbutton if the Disconnect setting does not require any changes, so this menu will jump to Step 6.
- Use the   buttons to adjust the Disconnect Voltage setting. Check the range for this value in the section 15 ('Specifications').
- Press the 'Enter'  pushbutton once to set/confirm the Disconnect Voltage setting, and this menu will jump to the Reconnect Voltage setting with the symbol  flashing.
- Use the   buttons to adjust the Reconnect Voltage setting. Check the range for this value in the section 15 ('Specifications').
- Press the 'Enter'  pushbutton once to set/confirm the Disconnect Voltage setting, and this menu will jump to Step 6

Note: The Reconnect Voltage has to be set to at least 0.5V above the Bulk Voltage setting. The unit blocks/changes invalid ones (see notes in section 15 'Specifications').

Step 6: DC-Load (terminals 5-6) ON/OFF Timers Enabling / Disabling

000

On OFF

OR

001

On OFF













1:08

On

2:06

OFF PM

The 'C00' or 'C01' setting will be shown on the display to indicate that the three DC-Load port timers are disabled or enabled respectively

- Press the 'Menu'  pushbutton if this setting does not require any changes, so this menu will jump back to Step 1.
- Use the   buttons to swap the setting between 'C00' (Manual-only ON/OFF) and 'C01' (Automatic ON/OFF by the timers).
- Press the 'Enter'  pushbutton once to set/confirm the setting
- With the 'C00' Manual-only ON/OFF setting, this menu will jump back to step 1 and all the three clock timers will be turned OFF and disabled but keeping their settings.
- With 'C01' Automatic ON/OFF with the timers setting, this menu will start showing the first timer ON time with the  symbol flashing periodically with a one-pulse pattern to indicate that the display is showing the corresponding value for timer 1.
- Use the same procedure as setting the Real Time Clock in step 1, by using the   and the "Enter"  pushbuttons, and follow with the OFF time of the timer 1 when the  symbol is shown.
- Then Press the 'Enter'  pushbutton once to set/confirm the setting of the ON and OFF time for timer 1, and this menu will repeat the process for timer 2, and then for timer 3, with their corresponding  and  symbols flashing periodically with a 2 and 3 pulses pattern respectively.
- After setting all the three timers, this menu will jump back to Step 1.

Notes: *a) The periodic pulse patterns of the ON and OFF alarm-clock-type symbols are very useful to indicate what timer the time value being shown and edited on the display belongs to. b) To disable whatever one or two of the three clock timers, just set the ON time to be the same as the OFF time (with whatever value) in the corresponding timer or timers. c) To disable all the three timers together without changing their corresponding ON/OFF settings, changes to the 'C00' (manual) setting. See more details in the section 11 "Understanding How the DC-Load port Timers Work".*

10. Operation and Maintenance:

The following periodic inspections and maintenance tasks are highly recommended for best performance.

- Verify the battery state of charge regularly.
- Check for any rusting or corrosion around the battery terminals.
- Verify that the connected solar panels and loads do not exceed the unit maximum ratings as per the tables in section #5 and in the specification section.
- Make sure that the average total energy consumption of the DC loads in “Ah” on a daily or weekly basis is less than the one that can be produced by the solar panel array, particularly when you rely exclusively on solar panel power. If necessary, consider resizing the system.
- Tighten all the terminal screws and inspect for any loose, broken, corroded, humid, and burned wire connections.
- Ensure the solar panels are mounted properly, trying to avoid partial shadows on them. Check for any dirt, debris, and corrosion on the solar panels.
- Ensure the controller is installed INDOORS in a dry location and away from heat sources.
- Periodically clean the solar panels with water and do not use chemicals.
- Allow free air flow under and over the solar panels for a proper heat dissipation.

11. Understanding How the DC-Load port Timers Work:

Following are two ways for turning the DC-Load port on and off.

- Manual-only ON/OFF: Select the ON/OFF setting to ‘C00’ to disable the three timers, allowing the user to turn the DC-Load ON/OFF only manually. To turn the DC-Load port either ON or OFF manually, press and hold the ‘Enter’ pushbutton for more than 3 seconds, so, whatever the ON and OFF condition is at a moment, it is toggled from ON/OFF to OFF/ON respectively.
- Automatic ON/OFF: Select the ON/OFF setting to ‘C01’ to enable the three timers and so the automatic ON and OFF periods for the DC-Load port. The setting of the three timers and the Real-time Clock are required, so the DC-Load port will turn ON or OFF automatically based on those timers settings in relation to the real-time clock. A maximum of three clock timers can be set, so the DC-Load could be turned ON and OFF up to three times a day. The Automatic ON/OFF settings does not preclude the use of the Manual ON/OFF; they can be combined.

Cancelling the timers: You can cancel all the timers by selecting the ‘C00’ setting explained above, or just one or more of the three timers, by selecting both ON and OFF time settings of the specific timer (or timers) to exactly the same whatever value (including their “PM” condition).

Timers setting examples: Following are five cases showing how the DC-Load port (terminals 5-6) is turned ON/OFF based on the corresponding timers settings and the ‘Enter’ pushbutton. In all the cases, the result is ON when at least one of the timers is ON. In other words, to be OFF, all the timers have to be OFF. This is called an “OR” function in digital logic.

Note: *In all the cases, you can toggle (reverse) the ON/OFF condition (whatever it is) at any time, by doing a manual ON/OFF with the “Enter” pushbutton as explained above.*

Case 1: The three timers are set up to be ON at different times and without overlapping each other. As a result, the DC-Load port turns ON and OFF three times a day.

Case 2: One of the Clock timers is overlapping another timer. As a result, the DC-Load port turns ON and OFF two times a day.



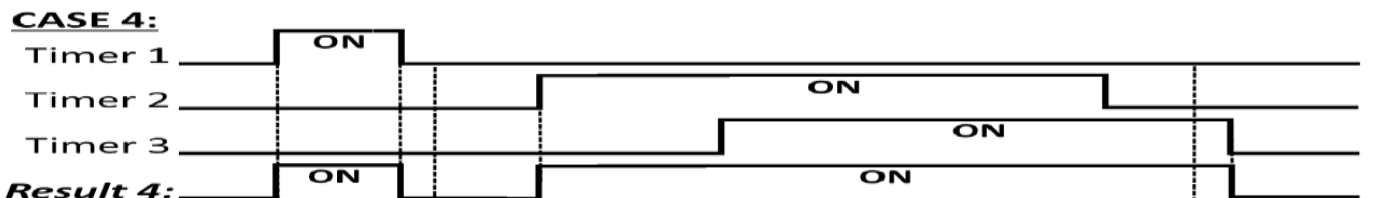
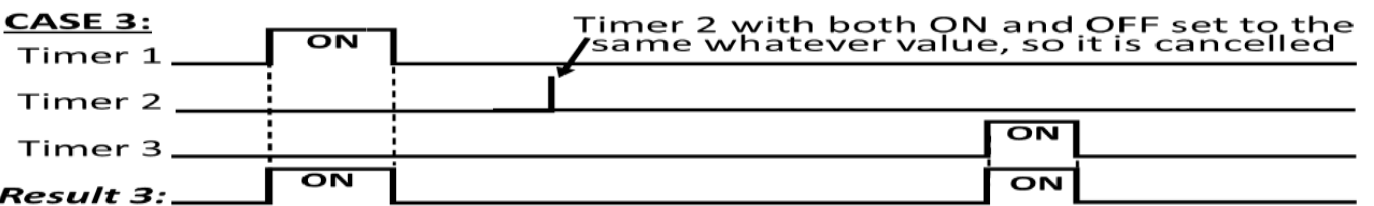
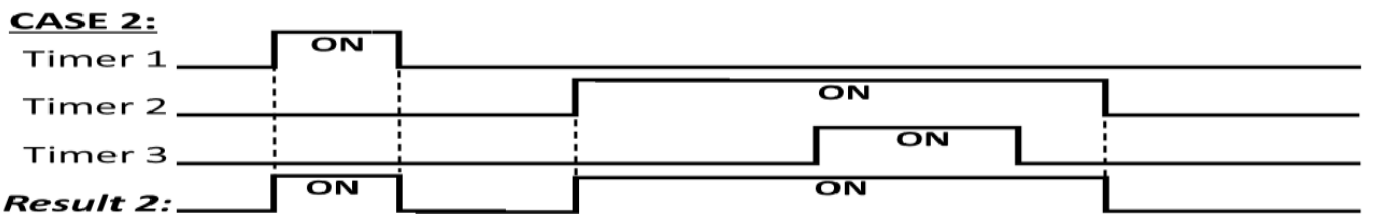
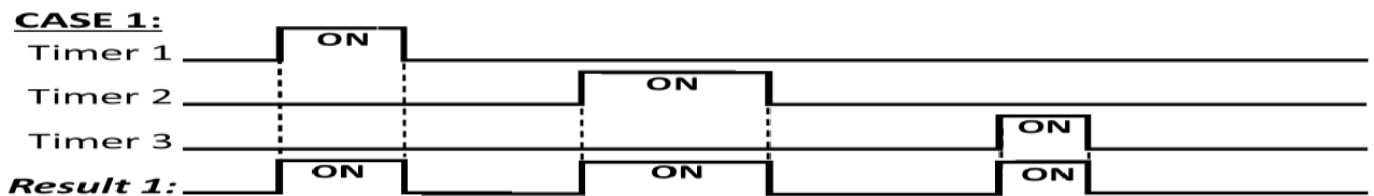

Case 3: The DC-Load port is required to turn ON two times a day only. In order to do that, one of the timers (in this example 'Timer 2') is set with its ON time and OFF time equal, so to cancel it. As a result, the DC-Load port turns ON and OFF two times a day.

Case 4: In this case, two of the three timers (Timer 2 and 3) are partially overlapping each other, resulting in a larger combined ON time. As a result, the DC-Load port turns ON and OFF two times a day.

Case 5: Is the same case 4 above, but with the "Enter" pushbutton used for manually toggling (reversing) the ON/OFF result of the timers settings. In this case, two interruptions of the automatic timers pattern occur, turning the DC-Load port ON and then OFF by using the "Enter" pushbutton. As a result, the DC-Load port turns ON and OFF two times a day. The first time with the same duration of Timer 1, and the second time, with the duration in between the pushing of the "Enter" pushbutton for longer than 3 seconds.



12. Checking the controller (fast test) after installed for the first time





- Select a time of the day with a good sunlight condition, enough for getting at least 17-18Voc from the solar panel array when it is in open circuit (disconnected from the controller).
- Emulate a darkness condition by turning over the solar panels so their photocell side points toward the floor/soil, or by covering them (e.g. with flat pieces of cardboard).
- Connect both the solar panel array and the battery to the controller, paying attention to their polarity. The unit should start running in Normal Operating Mode showing the battery voltage and the AGM symbol (as per the factory default). The battery symbol  should remain flashing all the time (in all the operating modes) to indicate that the unit is running OK.
- Turn over the solar panel or remove the cardboard slowly, so the photocells side starts getting sunshine radiation, so eventually you should see the sunshine symbol  going on, and eventually since then, its corresponding arrow symbol flashing to indicate a flow of charging current from the solar panel to the battery.
- With the display showing the symbols    on the top (with the two right most flashing), an increment of the displayed battery voltage should be expected, even a very small one. In addition, you should read a charging current in Amps, by pressing the \uparrow or \downarrow buttons, being proportional to the sunlight intensity, solar panel size (power), and the state of discharge of the battery.
- Optionally, and for a higher reading of the above Amps values, you can connect a DC load directly to the battery terminals.
- Finally change the settings according to your systems requirements (e.g. battery type, etc.)

Note: For the purpose of this test, make sure the DC-Load port (terminals 5-6) is always Off.

13. Understanding the Unit Error Code or Timer Code:

Code	Description
E01	Battery is connected with the polarity reversed. Connect it properly. See section 3.
E02	Solar panel input current is higher than 30A. Disconnect the panel to reset the error.
E03	DC-Load port is drawing more than 30A of current. Reduce the DC load power. The DC Load output will resume automatically after few seconds. It is checked every few sec.
E04	Unit has Over Temperature Shutdown. The unit will resume operation automatically after cools down.
E05	A DC-Load Disconnect occurred because the battery voltage dropped to the corresponding setting. The DC-Load port output will resume automatically when the battery voltage rises up to the corresponding DC-Load Reconnect voltage setting.
C00	DC-Load port timers for automatic On/Off are disabled. It can operate only manually.
C01	DC-Load port timers for automatic On/Off are enabled. It can operate manually as well.

14. Troubleshooting

Problem	Possible Cause/Condition	Solution
The unit is frozen (not responding) and the battery symbol  is <u>not</u> flashing	<p>The micro controller is in halt status, due to a slow dropping of the battery voltage below \approx 6.2V.</p> <p>This is an extreme condition that could happen when having DC loads connected directly to the battery terminals without any 'Low Voltage Disconnect' mechanism available, or after keeping the battery without any net charging current source for a long time.</p>	<p>⑥ RESET PROCEDURE: Allow* or help** the battery raising its voltage over 6.4-6.5V*. Then reset the controller by disconnecting the battery positive on terminal 3 and wait until the display goes blank. Then reconnect the battery positive.</p> <p>Notes: * Disconnect all possible loads connected directly to the battery and to the controller. ** Charge the battery by other means, and/or bypass the controller by connecting the solar panel directly to the battery for a while until it reaches more than 6.4 -6.5V.</p>
DC-Load port Off and the symbol  is Off	<p>It was not turned On either automatically or manually.</p> <p>It was turned Off either automatically or manually.</p>	For automatic clock operation, enable the timers with the "C01" setting, set their On and Off times, and wait. For manual On/Off operation, press and hold the 'Enter' pushbutton longer than 3 sec.
DC-Load port Off and the symbol  is Flashing	An error condition appears (e.g. E05) forcing the DC-Load port, that was On, to be Off .	Check the reason of the error in section 13 to fix it, or wait for its recovery.
DC-Load port Off and the symbol  is Solid On	<p>Loose connection on terminals 5-6</p> <p>Internal damage</p>	<p>Check DC-Load terminals 5-6 for loose connections, corrosion, etc.</p> <p>Contact Nature Power Customer service.</p>
The DC-Load port On/Off condition does not follow the timers settings	<p>Wrong setting for disabling particular timers (i.e. not having the same whatever On and Off times in their settings), and/or all the timers are disabled (i.e. having "C00" setting), and/or wrong On and Off times in one or more timers.</p> <p>Real Time Clock not matching the local time.</p>	<p>Check the section 11 for more details about the timers settings. Make sure to avoid non-desired overlapping timers when setting one or more of them.</p> <p>Pay attention to the 'PM' ('Post Meridieum') condition when setting the timers.</p> <p>Set the Real Time Clock correctly with the proper 'PM' condition.</p>

Wrong behavior of the display for few seconds before a complete shutdown	Battery was disconnected when the solar panel was providing power. It could be due to a change in the position of a battery selector/switch that feeds the controller.	If the disconnection was done on purpose, just wait for few seconds until the unit shuts down. Otherwise, check for loose contacts on all the terminals related to the battery, and for Potential open conditions on battery fuses and switches.
Solar panel voltage is above the battery voltage	The PWM voltage regulation is taking place, having enough sunlight and the battery fully charged or close to it.	This is normal (not a problem).
Battery is not charging and the symbol ☀ is Off	There is not enough voltage coming from the solar panel, so it is not being detected.	Wait for a better sunlight condition, and/or readjust the solar panel position for better alignment with the sun.
Battery is not charging having the symbols * ☑ on the display	The solar panel was detected but its voltage is not enough to start supplying charging current yet, so the corresponding flow current arrow is not shown.	These conditions are normal when out or almost out of the daytime hours.
Battery is not charging (its voltage drops continuously) having * → ☑ on the display	The solar panel is providing charging current, but it seems to be lower than the total discharging current from the battery, so its voltage is dropping.	Make sure this condition does not persist indefinitely to avoid discharging the battery. Reduce the DC loads connected to the controller's DC-Load port and/or directly to the battery (if any).

15. Specifications

Battery Voltage System (nominal)	12V/24V (Autosensed)
Minimum Operating Battery Voltage ^⑦	6.2V ± 0.1V (for 12V and 24V)
Minimum Operating Battery Voltage Recovery	≈ 0.2V over the above value
Solar Panel Open Circuit Voltage (max.)	26VDC*
Charging Current (max.)	30A
Load Current (max.)	30A
Operating Self Consumption Current	< 40mA
Charge Controller Regulation Type	PWM (Pulse Width Modulation)
Charge Controller Grounding Type	Negative Grounding
Battery Type Factory Default	AGM

Regulated Voltage:	
Flooded Battery (fixed)	Bulk:14.4V, Float:13.5V*
GEL (fixed)	Bulk:14.2V, Float:13.8V*
AGM (fixed)	Bulk:14.3V, Float:13.4V*
Lithium (adjustable @ 0.1V steps)	Bulk:13.9-14.6V, Float:13.0-14.4V*
Lithium Factory Default:	Bulk:14.2V, Float:13.8V*
Program (adjustable @ 0.1V steps)	Bulk:13.9-15.0V, Float:13.0-14.0V*
Program Factory Default:	Bulk:14.4V, Float:13.5V*
Max. Float voltage in Lithium & Program ⑧	0.2V below the Bulk setting*
DC-Load (terminals 5-6) Disconnect /Reconnect:	
Disconnect Voltage (adjustable @ 0.1V steps)	10-13V*
Disconnect Voltage Factory Default	10.5V*
Reconnect Voltage (adjustable @ 0.1V steps)	10.5 – 13.5V*
Reconnect Voltage Factory Default	12V*
Minimum Reconnect Voltage ⑨	0.5V above the Disconnect setting*
Factory Default Status of the three On/Off Timers	C00 (disabled)
Factory Default On/Off time for the three timers	12:00 (AM) -->disabled if C01 selected
Allowable Direct Wires Size (as per the physical connector & terminals used)	# 6 AWG max.
Minimum Required Wires Size	# 10 AWG
Protections:	
Battery Reverse Polarity	Yes (E01 error)
Solar Panel Reverse Polarity	Yes
DC-Load port Current Overload	Yes (E03 error)
Solar Panel Current Overload	Yes (E02 error)
Over Temperature	Yes (E04 error)
Operating Temperature	- 40 to 60 °C (-40 to 140 °F)
Dimensions (L x W x H)	6.7x4.7x1.7 inches (170x120x43 mm)
Weight	1.20lb (545g)

Notes:

* Voltage is double when the unit is used on 24V battery systems.

⑦ Below that voltage, the  symbol may stop flashing on the display to indicate that the unit is not running and requires to be reset as explained in point ⑥ in the troubleshooting table on section 14.

⑧ The floating voltage must be at least 0.2V below the Bulk one. The unit enforces that if necessary by either restricting or changing the non-valid values to meet that requirement, and according to the Bulk setting.

⑨ The DC-Load port Reconnect Voltage must be at least 0.5V above the Disconnect one. The unit enforces that if necessary by either restricting or changing the non-valid values to meet that requirement, and according to the Disconnect setting voltage.

16. Warranty

1 Years Limited Warranty

The limited warranty program is the only one that applies to this unit, and it sets forth all the responsibilities of Nature Power. There is no another warranty, other than those described herein. Any implied warranty of merchantability of fitness for a particular purpose on this unit is limited in duration to the duration of this warranty. This unit is warranted, to the original purchaser only, to be free of defects in materials and workmanship for 1 years from the date of purchase without additional charge. The warranty does not extend to subsequent purchasers or users. The manufacturer will not be responsible for any amount of damage in excess of the retail purchase price of the unit under any circumstances. Incidental and consequential damages are specifically excluded from coverage under this warranty. This unit is not intended for commercial use. This warranty does not apply to damaged units from misuse or incorrect installation/ connection. Misuse includes wiring or connecting to improper polarity power sources.

Return/Repair Policy:

If you are experiencing some problems with your unit, please contact our customer service 1-800-588-0590 before returning the product to the retail store. After speaking to a customer service representative, if the product seems non-working or malfunctioning, it may be returned to the purchasing store within 30 days of original purchase. Any defective unit that is returned to the manufacturer within 30 days of the date of purchase will be replaced free of charge. If such a unit is returned more than 30 days but less than one year from the purchase date, the manufacturer will repair the unit or, at its option, replace it, free of charge. If the unit is repaired, new or reconditioned replacement parts may be used at manufacturer's option. A unit may be replaced with a new or reconditioned unit of the same or comparable design. The repaired or replaced unit will then be warranted under these terms for the remainder of the warranty period. The customer is responsible for the shipping charges on all returned items.

LIMITATIONS:

This warranty does not cover accessories, such as adapters and batteries, damages or defects that result from normal wear and tear (including chips, scratches, abrasions, discoloration or fading due to usage or exposure to sunlight), accidents, damages during shipping to our service facility, alterations, unauthorized use or repair, neglect, misuse, abuse, failure to follow instructions for care and maintenance, fire and flood. If your problem is not covered by this warranty, contact our Customer Service 1-800-588-0590 for general information if applicable.



Please contact Nature Power Products to acquire more information:

1-800-588-0590

info@naturepowerproducts.com

www.naturepowerproducts.com

Made in China